

5 V, SUPER MINIMOLD SILICON RFIC WIDEBAND AMPLIFIER

FEATURES

- **WIDE FREQUENCY RESPONSE:** 2.7 GHz
- **FLAT GAIN RESPONSE:** ± 1.0 dB
- **HIGH GAIN:** 23 dB
- **MEDIUM OUTPUT POWER:** P_{1dB} : 6.0 dBm at 1.0 GHz
- **5 V SINGLE SUPPLY VOLTAGE**
- **SMALL SURFACE MOUNT PACKAGE:** SOT-363
- **AVAILABLE ON TAPE AND REEL**

DESCRIPTION

NEC's UPC2776TB is a Silicon Monolithic integrated circuit which is manufactured using the NESAT™III process. This device is suitable for wide band IF blocks due to its high gain and flat response. The UPC2776TB is pin compatible and has comparable performance as the larger UPC2776T, so it is suitable for use as a replacement to help reduce system size. The IC is housed in a 6 pin super minimold or SOT-363 package. The UPC2776TB is designed as a low cost IC gain stage in DBS, TVRO, PCS, WLAN and other communication receivers.

GAIN vs. FREQUENCY

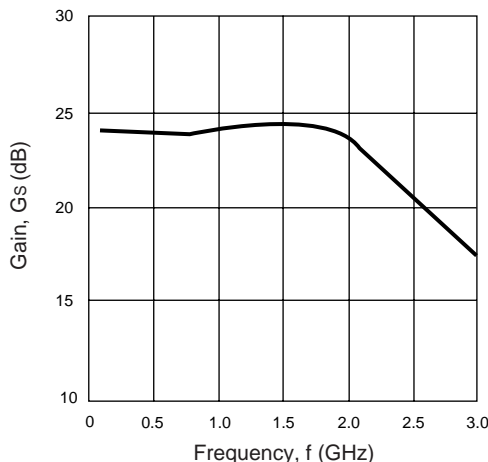

TEST CIRCUIT

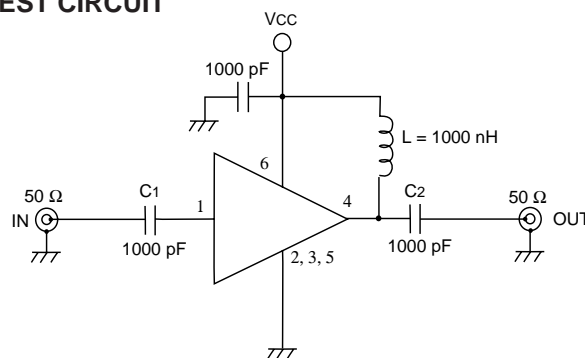

ELECTRICAL CHARACTERISTICS ($V_{CC} = 5.0$ V, $T_A = 25^\circ\text{C}$, $Z_L = Z_S = 50 \Omega$)

PART NUMBER PACKAGE OUTLINE			UPC2776TB S06		
SYMBOLS	PARAMETERS AND CONDITIONS	UNITS	MIN	TYP	MAX
I_{CC}	Circuit Current (no signal)	mA	18	25	33
G_s	Small Signal Gain, $f = 1$ GHz	dB	21	23	26
f_u	Upper Limit Operating Frequency (The gain at f_u is 3 dB down from the gain at 0.1 GHz)	GHz	2.3	2.7	
ΔG_s	Gain Flatness, $f = 0.1$ to 2.0 GHz	dB		± 1.0	
P_{1dB}	Output Power at 1 dB Compression, $f = 1$ GHz	dBm	+4	+6.0	
NF	Noise Figure, $f = 1$ GHz	dB		6.0	7.5
RL_{IN}	Input Return Loss, $f = 1$ GHz	dB	4.5	7.5	
RL_{OUT}	Output Return Loss, $f = 1$ GHz	dB	15	20	
ISOL	Isolation, $f = 1$ GHz	dB	27	32	
$PSAT$	Saturated Output Power, $f = 1$ GHz	dBm		8.5	
IM_3	3rd Order Intermodulation Distortion, $f = 1$ GHz $P_o = 0$ dBm each tone, $f_1 = 1000$ MHz, $f_2 = 1002$ MHz	dBc		-30	

The information in this document is subject to change without notice. Before using this document, please confirm that this is the latest version.

ABSOLUTE MAXIMUM RATINGS¹ (T_A = 25°C)

SYMBOLS	PARAMETERS	UNITS	RATINGS
V _{CC}	Supply Voltage	V	6
I _{CC}	Total Circuit Current	mA	60
P _{IN}	Input Power	dBm	+10
P _T	Total Power Dissipation ²	mW	200
T _{OP}	Operating Temperature	°C	-40 to +85
T _{STG}	Storage Temperature	°C	-55 to +150

Notes:

1. Operation in excess of any one of these parameters may result in permanent damage.
2. Mounted on a 50 x 50 x 1.6 mm epoxy glass PWB (T_A = 85°C).

RECOMMENDED OPERATING CONDITIONS

SYMBOLS	PARAMETERS	UNITS	MIN	TYP	MAX
V _{CC}	Supply Voltage	V	4.5	5.0	5.5

ORDERING INFORMATION (Solder Contains Lead)

PART NUMBER	QTY
UPC2776TB-E3	3K/Reel

Note:

Embossed Tape, 8 mm wide. Pins 1, 2 and 3 face perforated side of tape.

ORDERING INFORMATION (Pb-Free)

PART NUMBER	QTY
UPC2776TB-E3-A	3K/Reel

Note:

Embossed Tape, 8 mm wide. Pins 1, 2 and 3 face perforated side of tape.

TYPICAL PERFORMANCE CURVES (T_A = 25°C)

CURRENT vs. VOLTAGE

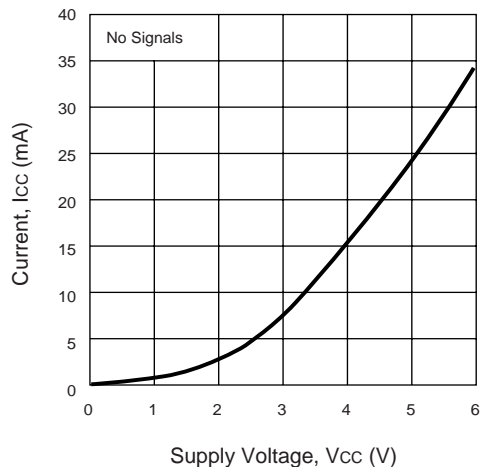

CURRENT vs. TEMPERATURE

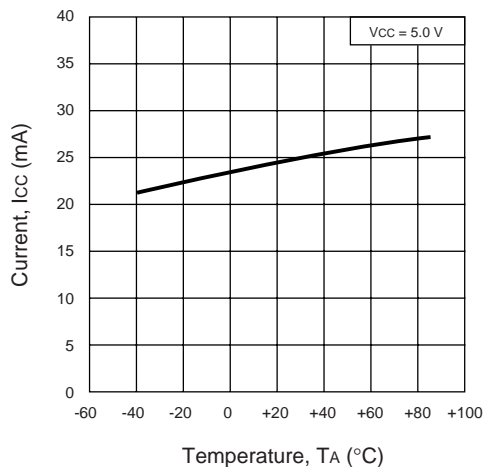

NOISE FIGURE AND GAIN vs. FREQUENCY and VOLTAGE

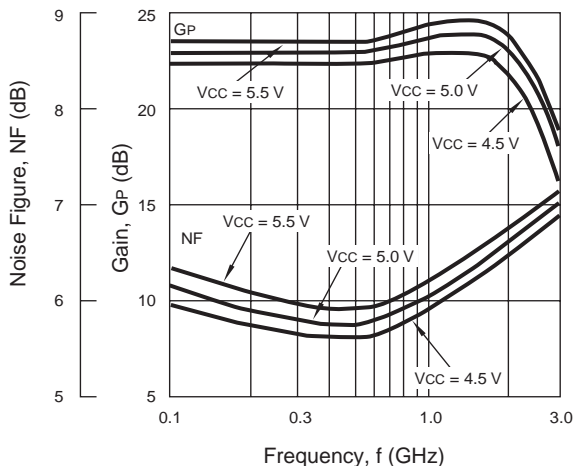

GAIN vs. FREQUENCY and TEMPERATURE

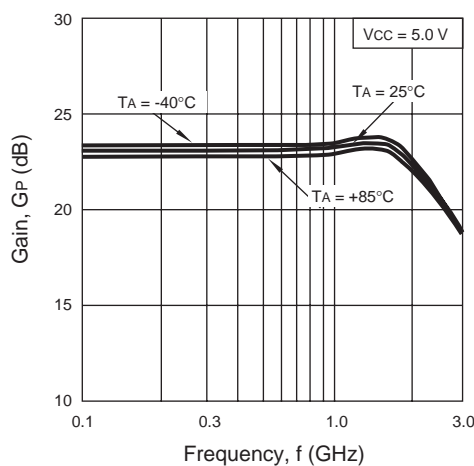

TYPICAL PERFORMANCE CURVES (TA = 25° C)

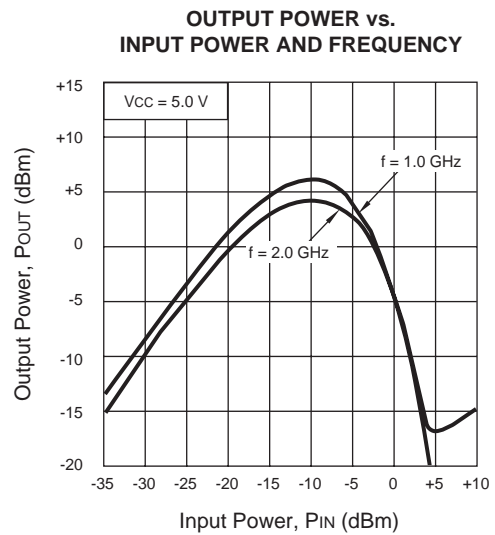
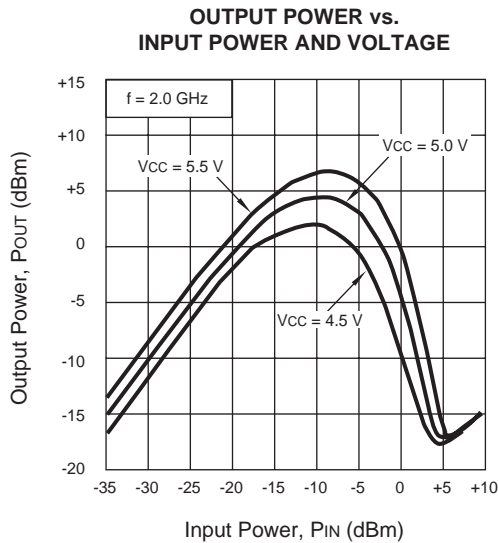
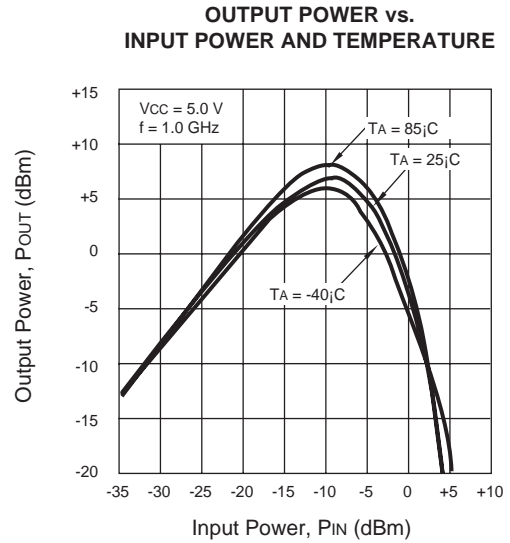
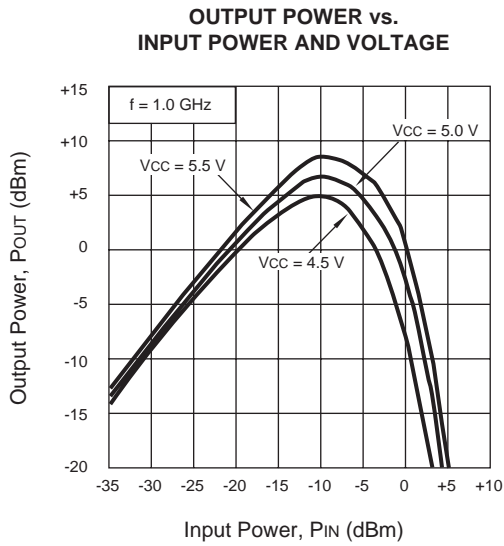
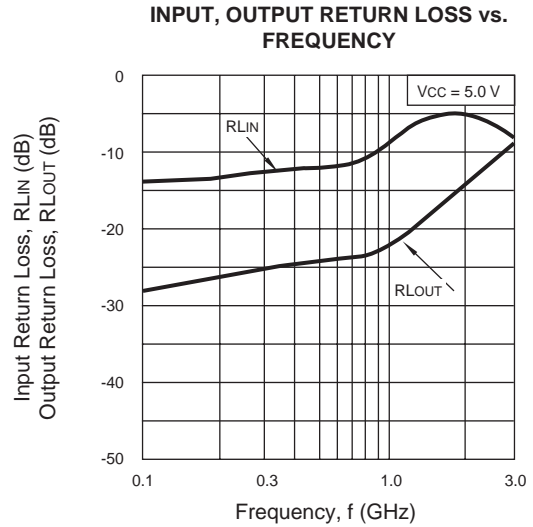
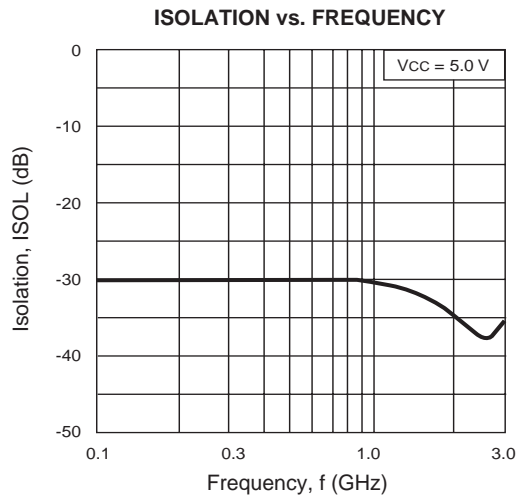

TYPICAL PERFORMANCE CURVES (TA = 25° C)

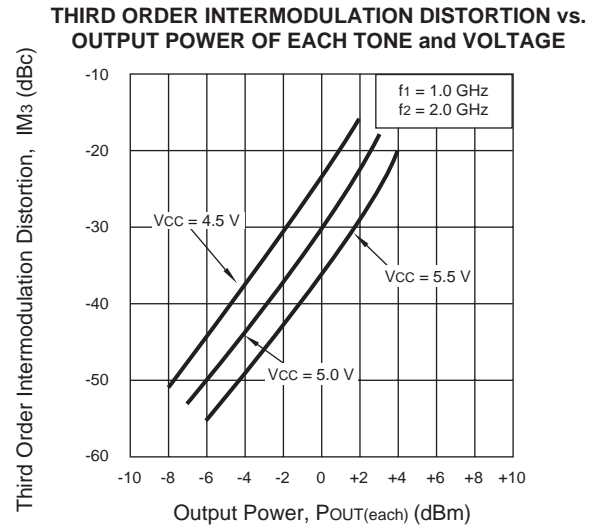
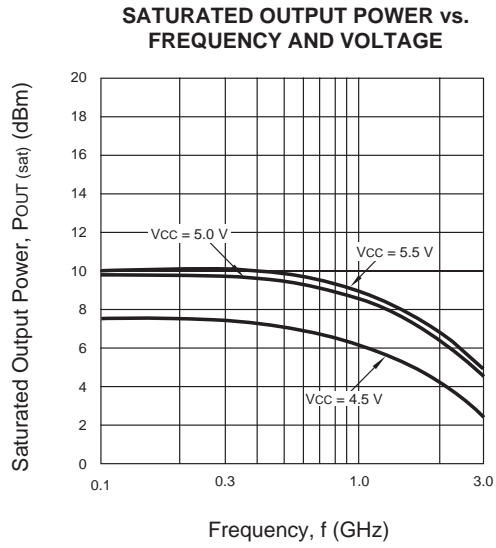

TYPICAL SCATTERING PARAMETERS (T_A = 25°C)

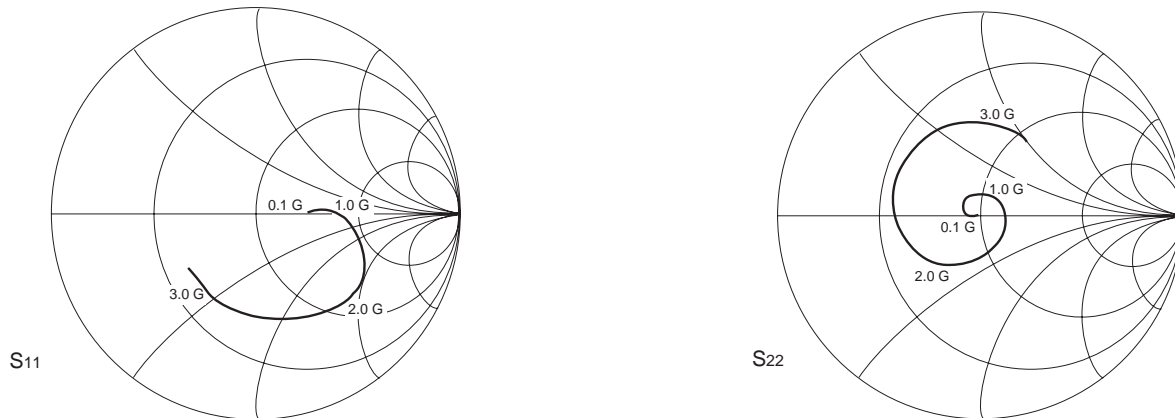

UPC2776TB

V_{CC} = V_{OUT} = 5.0 V, I_{CC} = 27 mA

FREQUENCY GHz	S ₁₁		S ₂₁		S ₁₂		S ₂₂		K
	MAG	ANG	MAG	ANG	MAG	ANG	MAG	ANG	
0.1	0.226	2.8	13.844	-5.9	0.029	-1.5	0.032	-177.4	1.39
0.2	0.240	6.4	13.862	-12.5	0.029	0.3	0.024	-171.9	1.39
0.3	0.254	10.4	13.942	-18.6	0.028	3.2	0.030	-176.3	1.40
0.4	0.267	11.4	14.123	-25.2	0.029	4.8	0.031	-167.6	1.36
0.5	0.285	11.1	14.267	-31.8	0.029	7.2	0.037	-167.3	1.33
0.6	0.308	8.5	14.423	-38.6	0.029	9.3	0.038	-159.3	1.28
0.7	0.345	6.1	14.670	-45.5	0.030	10.7	0.040	-160.7	1.22
0.8	0.386	3.9	14.864	-52.8	0.030	11.0	0.043	-161.9	1.18
0.9	0.425	1.4	15.210	-60.1	0.031	11.9	0.055	-169.0	1.12
1.0	0.449	-1.5	15.455	-68.4	0.030	11.7	0.072	-169.1	1.10
1.1	0.466	-6.1	15.564	-76.6	0.030	10.6	0.084	-169.1	1.08
1.2	0.478	-12.0	15.550	-84.9	0.030	11.7	0.093	-173.6	1.07
1.3	0.507	-17.7	15.622	-93.1	0.030	13.4	0.094	177.9	1.05
1.4	0.533	-24.7	15.577	-101.3	0.029	13.2	0.114	167.0	1.05
1.5	0.564	-30.3	15.527	-110.6	0.029	13.5	0.130	164.1	1.02
1.6	0.568	-36.4	15.285	-119.0	0.027	11.3	0.154	158.0	1.07
1.7	0.576	-42.0	14.960	-127.8	0.026	12.6	0.167	152.6	1.09
1.8	0.571	-48.5	14.570	-136.4	0.024	14.8	0.179	143.0	1.18
1.9	0.570	-54.5	14.026	-144.7	0.023	15.8	0.196	135.2	1.27
2.0	0.569	-59.7	13.715	-151.7	0.022	18.2	0.212	128.1	1.35
2.1	0.564	-64.2	13.283	-159.8	0.020	23.5	0.228	121.6	1.48
2.2	0.548	-69.6	12.926	-167.5	0.018	27.1	0.240	115.9	1.66
2.3	0.535	-75.5	12.515	-174.8	0.018	36.3	0.251	108.1	1.75
2.4	0.516	-81.8	12.093	-177.9	0.016	41.9	0.268	102.4	2.01
2.5	0.515	-87.0	11.498	170.1	0.017	53.3	0.279	96.0	1.99
2.6	0.508	-90.9	11.136	163.1	0.015	64.3	0.296	90.8	2.22
2.7	0.503	-94.8	10.511	156.6	0.015	67.9	0.306	86.7	2.29
2.8	0.489	-97.6	10.126	148.3	0.018	85.0	0.315	79.2	2.00
2.9	0.471	-101.3	9.850	143.2	0.019	993.7	0.330	73.0	1.96
3.0	0.457	-106.7	9.242	135.5	0.022	100.0	0.343	67.0	1.81
3.1	0.455	-111.3	9.065	128.9	0.026	108.0	0.357	60.7	1.53

PIN DESCRIPTIONS

Pin No.	Symbol	Applied Voltage	Description	Internal Equivalent Circuit
1	Input	–	RF signal input pin. An internal matching circuit, configured with resistors, improves match to 50 Ω over a wide band. A multi-feedback circuit is incorporated to minimize variations in hFE and resistance values.	
2 3 5	GND	0	Ground pins. From the ground pattern as large as possible to minimize ground impedance.	
4	Output	4.5 to 5.5	RF signal output pin. Connect an inductor between this pin and Vcc to supply current to the internal output transistors.	
6	Vcc		Power supply pin. This pin biases the internal input transistor.	

OUTLINE DIMENSIONS (Units in mm)

PACKAGE OUTLINE S06

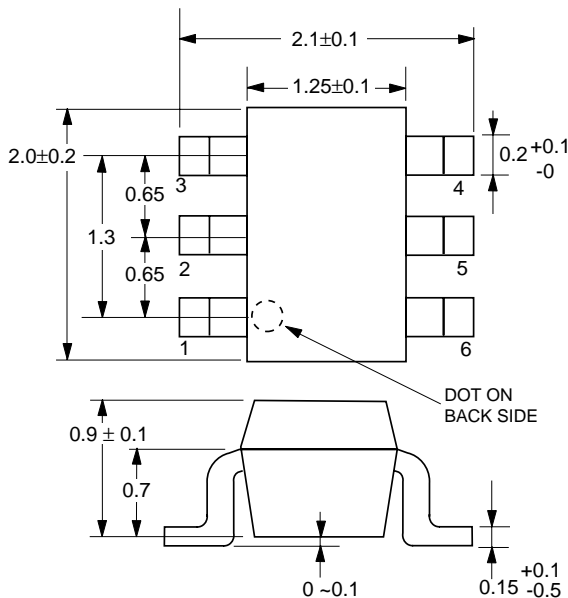

Note: All dimensions are typical unless otherwise specified.

LEAD CONNECTIONS

(Top View)

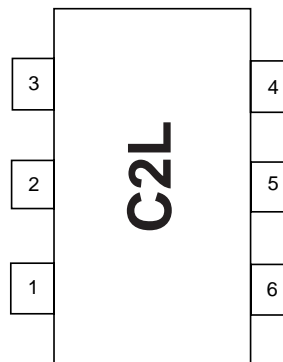

(Bottom View)

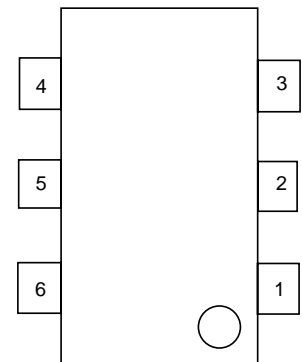

- 1. INPUT
- 2. GND
- 3. GND
- 4. OUTPUT
- 5. GND
- 6. Vcc

Note: Package Marking
C2L: UPC2776TB

Life Support Applications

These NEC products are not intended for use in life support devices, appliances, or systems where the malfunction of these products can reasonably be expected to result in personal injury. The customers of CEL using or selling these products for use in such applications do so at their own risk and agree to fully indemnify CEL for all damages resulting from such improper use or sale.

CEL California Eastern Laboratories, Your source for NEC RF, Microwave, Optoelectronic, and Fiber Optic Semiconductor Devices.

4590 Patrick Henry Drive • Santa Clara, CA 95054-1817 • (408) 919-2500 • FAX (408) 988-0279 • www.cel.com

DATA SUBJECT TO CHANGE WITHOUT NOTICE

Subject: Compliance with EU Directives

CEL certifies, to its knowledge, that semiconductor and laser products detailed below are compliant with the requirements of European Union (EU) Directive 2002/95/EC Restriction on Use of Hazardous Substances in electrical and electronic equipment (RoHS) and the requirements of EU Directive 2003/11/EC Restriction on Penta and Octa BDE.

CEL Pb-free products have the same base part number with a suffix added. The suffix –A indicates that the device is Pb-free. The –AZ suffix is used to designate devices containing Pb which are exempted from the requirement of RoHS directive (*). In all cases the devices have Pb-free terminals. All devices with these suffixes meet the requirements of the RoHS directive.

This status is based on CEL’s understanding of the EU Directives and knowledge of the materials that go into its products as of the date of disclosure of this information.

Restricted Substance per RoHS	Concentration Limit per RoHS (values are not yet fixed)	Concentration contained in CEL devices	
		-A	-AZ
Lead (Pb)	< 1000 PPM	Not Detected	(*)
Mercury	< 1000 PPM	Not Detected	
Cadmium	< 100 PPM	Not Detected	
Hexavalent Chromium	< 1000 PPM	Not Detected	
PBB	< 1000 PPM	Not Detected	
PBDE	< 1000 PPM	Not Detected	

If you should have any additional questions regarding our devices and compliance to environmental standards, please do not hesitate to contact your local representative.

Important Information and Disclaimer: Information provided by CEL on its website or in other communications concerning the substance content of its products represents knowledge and belief as of the date that it is provided. CEL bases its knowledge and belief on information provided by third parties and makes no representation or warranty as to the accuracy of such information. Efforts are underway to better integrate information from third parties. CEL has taken and continues to take reasonable steps to provide representative and accurate information but may not have conducted destructive testing or chemical analysis on incoming materials and chemicals. CEL and CEL suppliers consider certain information to be proprietary, and thus CAS numbers and other limited information may not be available for release.

In no event shall CEL’s liability arising out of such information exceed the total purchase price of the CEL part(s) at issue sold by CEL to customer on an annual basis.

See CEL Terms and Conditions for additional clarification of warranties and liability.